



INDUSTRIAL Fuel Air Separation System

INSTALLATION MANUAL For Trucks Equipped with CUMMINS® ISX15 Common Rail & X15



Part No. A3SPBT453

**PLEASE READ
THESE INSTRUCTIONS
THOROUGHLY
BEFORE BEGINNING
INSTALLATION**

NOW WITH DEMAND FLOW

Revised 05/06/2024



Proudly Made in the USA

**www.airdogdiesel.com
1-573-635-0555 or
1-877-463-4373**

Providing "Test Cell Performance" in "Real World Conditions" Since 1993!

PATENT

www.AirDogDiesel.com/patents

AirDog[®] INDUSTRIAL Fuel Air Separation System

THE RIGHT CHOICE FOR YOUR DIESEL ENGINE

4G-HD Fuel Pump

Pump shaft, stabilized with bearings on each end, holds the gerotor in virtually perfect alignment for quiet running and extended longevity!



Low Fuel Pressure Switch and LED Indicator

Lets you know when to service the fuel filter and water separator before suffering power loss. NO MORE GUESSING!



Positive Air Separation with primary air discharge port.



Demand Flow System

Easy installation, only one small line connected to the engine return line to return air/vapor to the tank.

Bearings



LoveJoy Coupler System

The LoveJoy Coupler System is self-aligning and eliminates virtually all vibrations.



Dual Port Pump

Balances the gerotor for quiet operation and higher flows.



Protective Wire Screen

In water separator nipple.



Adjustable Regulator

For just the right fuel pressure.

6 Micron Particulate Filters
Long-Lasting MicroGlass Media

Water Separator/Pre-Filter
With a High-Quality and High-Absorbency
Hydrosorb Media

CARB Executive Orders D-595-5 & D-595U-6 permit the advertisement, sales and installation of PureFlow Technologies AirDog[®] Diesel Fuel Systems in California on 2020 and older model year on-road diesel vehicles and off-road diesel vehicles/equipment.

SYSTEM OVERVIEW



Welcome to the AirDog® Heavy Duty Industrial Fuel Air Separation System for Class 8 Trucks

The AirDog®, with **ADVANCED FUEL AIR SEPARATION, DEMAND FLOW, ADJUSTABLE REGULATOR, LOW PRESSURE SENSOR with LED INDICATOR** and the **4G-HD FUEL PUMP**, is a premium fuel filtration and delivery system for the Cummins ISX15 Common Rail & X15 Diesel Engines.

The “**VACUUM FEED FILTER SYSTEM**” currently on your engine passes entrained air to the engine and increases cavitation and vapor as the fuel filter plugs with use!

With Air & Vapor present in the fuel, the effective stroke of the High Pressure Pump and output volume of fuel to the Common Rail is reduced. This adversely affects both the injection rate and also the shape of the injection spray pattern, which results in increased fuel consumption and increased exhaust emissions.

AirDog® removes the entrained air from the fuel and prevents the formation of vapor in the high pressure pump to restore the efficiency of the Common Rail System.

Diesel engines, regardless of which type of fuel injection system they may have, when equipped with the AirDog®, can now perform as designed, delivering “test cell” performance while in “real world” use!

The AirDog® removes water, particulates and most importantly, the entrained air from the fuel flowing to your engine. The entrained air and vapor separated from the fuel is returned to the fuel tank. The fuel flow to the engine’s transfer pump is maintained at a **NET POSITIVE PRESSURE HEAD** preventing cavitation and the formation of vapor thus overcoming the performance related problems from plugged fuel filters, torque loss at higher engine RPM, and high altitude operation.

All AirDog® products are manufactured with a personal touch, unsurpassed attention to detail and the most stringent quality assurance!

TYPICAL INSTALLATION LAYOUT



Figure 1

The AirDog® requires only one small return line connected to the engine return line, for quick and easy installations.

TABLE OF CONTENTS

Section 1.....Table of Contents
Section 2.....Installation and Safety Guidelines
Section 3.....Parts List

INSTALLATION PROCEDURES

Section 4.....Selecting the Best Mounting Location
Section 5A & B.....Mounting the AirDog® & Mounting Brackets

Fuel Lines, Fittings & Low Fuel Pressure Sensor Switch

Section 6A.....Fittings & Fuel Pressure Sensor
Section 6B.....AirDog® Air/Vapor Return Line
Section 6C.....Fuel Line from Tank & to Engine

Wire Harness

Section 7.....Wire Harness
Section 8.....Initial Start Up

Maintenance

Section 9.....Filter Service

Section 2

Installation & Safety Guidelines

The installation of your AirDog® can be made relatively easy by following the steps outlined in this manual, and:

1. Inventory the package components. Immediately notify PureFlow® Technologies, Inc., of any missing or damaged parts.
2. Read the installation manual completely. Understand how the system operates and the installation recommendations before beginning.
3. Proper location of the AirDog® on the vehicle is essential. Consider hazards presented to the equipment by road debris and the elements.
4. The installation recommendations and guidelines contained herein are suggestions only. Individual installations may vary.
5. Use diesel compatible thread sealer when installing fittings with NPT threads. (Loctite® 545 Thread Sealer is diesel compatible.)

DO NOT REMOVE FACTORY INSTALLED SECONDARY FUEL FILTERS. REMOVAL OF A FACTORY INSTALLED SECONDARY FUEL FILTER MAY VOID YOUR ENGINE WARRANTY.

SAFETY GUIDELINES

CAUTION: Chock the vehicle’s tires to prevent rolling.

CAUTION: Disconnect the battery cables before proceeding with the AirDog® installation.

CAUTION: Wear safety glasses when operating power tools such as drills and grinders or when using a punch or chisel.

CAUTION: Do Not drill into or weld the top of the frame rail or within 1-½” of the frame rail flange on the side of the frame rail.

CAUTION: Route the fuel lines and electrical harnesses keeping them away from hot exhaust components and/or moving parts. Properly secure the fuel lines and electrical harnesses to prevent chafing using zip ties included in installation kit.

CAUTION: Do not subject the AirDog® system directly to high-pressure wash systems. Doing so may damage seals and electrical components, and such damage is NOT covered under warranty.





**If you are uncertain of any installation procedure, please call:
PureFlow® Technologies, Inc. at 573-635-0555 for technical assistance.**

NOTE: The pictures used in this manual are for example only and may not depict the exact components as found on your truck.



Section 3

Installation Parts List



Parts List

QTY	Description	Part Number	Image
1	Installation Manual	206-1-0453	
1	AirDog® - with Serial Number Plate Fuel Filter FF200-MG-6 Water Separator WS200-HS	FPII-200-LP	
1	Wire Harness w/ Indicator Light & Dash Plate Includes: 1 ea Indicator Light (5G-1-1-47674) 1 ea Dash Plate (201-3-0004-S-M716)	5E-2-010 908-5G-1-1-47674	
1	3/8" Low Pressure Hose (Air/Vapor Return Line) - 7 ft Section	4C-1-02-05-010-7FT	





ADFK-453 Installation Kit

1	Fuel Pressure Sensor	908-5C-9-007-SC-06 <i>or</i> 908-5C-9-0010	
15	12" Zip Ties	5H-2-1-12	











908-00-0304 Frame Mount Bracket Kit

1	Left Mounting Bracket	002-3C-0003	
1	Right Mounting Bracket	002-3C-0004	
1	901-08-0100 Frame Mount Bracket Bolt Kit Includes: 4 ea 3/8-16 x 1-1/4 HHCS 4 ea 1/4-20 x 2 SHCS 908-08-0100-N Nut Packet 4 ea 3/8-16 Hex Nut & 4 ea 1/4-20 Hex Nut 908-08-0100-W Washer Packet 4 ea 3/8 Split Lock Washer & 4 ea 1/4 Split Lock Washer	1J-1-C20SZ 1L-A32C <i>1S-1-CSZ & 1S-1-AC</i> <i>1R-6-CSZ & 1R-6-AC</i>	

908-08-0800 AirDog® FPII Basic Fitting Kit

2	#10M JIC x 1/2 M NPTF Straight Connector	4A-1-01-10-08-S	
2	#10M JIC x #10F JICX 90° Swivel Nut Elbow	4A-2-04-10-10-S	
1	#6M JIC x 1/4 M NPTF Straight Connector	4A-1-01-A-C-SZ	
1	3/8 ID, 7/8 OD Rubber Grommet	5J-1-1-04-2758	

908-01-040753-FK Fitting Kit

2	1/2 Quick Connect x 1/2 NPT Adapter (for use with DAVCO filter housing with plastic quick connect fuel lines)	001-4A-1-0050	
2	Quick Connect 1/2 Return Adapter (for use with Paccar filter housing with quick connect fuel lines)	001-4A-1-0052	
1	Quick Connect Return Adapter Sub-Assy	908-VM-QCRA	
1	1-1. Quick Connect Return Adapter	001-4A-1-0051	
1	1-2. 1/4 NPT w/ Vibraseal Pipe Plug	4A-3-01-A-S2	
1	1-3. 12.5 x 2.5 mm O-Ring	1U-2-1-12.5	
1	1-4. Quick Connect Retainer Clip	4C-2-00-00	
1	1-5. #6M JIC x 1/4 M NPTF Straight Connector	4A-1-01-A-C-SZ	
1	#8M JIC x #8F JICX x 1/4 NPTF Port GagePort	4A-1-11-08-08-4P	
1	#6M JIC x 1/4 M NPTF Straight Connector	4A-1-01-A-C-SZ	
1	#8F JICX x 3/8 Push-lock Hose Barb	4A-1-09-08-06-B	
1	1/2 F NPT x 1/2 F NPT x 1/2 F NPT Tee	4A-4-03-08-08-08-S	
1	#8M JIC x 1/2 M NPTF Straight Connector	4A-1-01-08-08-S	
2	#6F JICX x 3/8 Push-lock Hose Barb	4A-1-09-06-06-B	
2	#6M JIC x #6F JICX 90° Swivel Nut Elbow	4A-2-04-06-06-S	

Selecting the Best Location to Mount the AirDog®

Installing the AirDog® at the proper location on the vehicle is most important. When deciding where to locate the AirDog®, the following points should be considered:

- Protection from the elements and road debris
- Accessibility for service

CAUTION: DO NOT mount the AirDog® directly on the engine. Mounting the AirDog® directly on the engine will immediately VOID your AirDog® Warranty!

NOTE: On various class 8 trucks, the manufacturer may use other than traditional steel braid fuel lines. These lines require special fittings. The fittings used with the original primary fuel filter are specific to the fuel lines used on the truck. When possible, mount the AirDog® in the location that will allow the use of the original fuel lines and fittings.

The following examples, Figures 2 thru 5, show different AirDog® installations. There are many variations in the arrangements and the components on the various trucks. With a little ingenuity, the AirDog® can be successfully installed on any class 8 truck.

Figure 2 shows the original fuel filter mounted on a bracket to the rear of the engine compartment and just above the frame behind the steering column.



Figure 2



Figure 3

Figure 3 shows the primary fuel filter mounted on the frame.

In Figure 4, the AirDog® is mounted on the original fuel filter bracket high above the frame and toward the front of the engine compartment.



Figure 4



Figure 5

The installation in figure 5 shows the AirDog® mounted on the frame on the passengers side, up front by the radiator.

Section 5: Mounting AirDog® on the Truck's Frame (Drilling Method)

NOTE: Do Not mount the AirDog® on the engine! Mounting the AirDog® on the engine will immediately void the AirDog® warranty. Mount the AirDog® on the truck frame.

5A-1. Remove the original primary fuel filter from the vehicle.



Figure 6



Figure 7

5A-2. Hold the AirDog® with the brackets and filters attached next to the frame.

5A-3. Turn the steering wheel fully to the left and to the right to check for tire clearance.



Figure 8



Figure 9

5A-4. Mark and center punch each hole location.

5A-5. Drill a 3/8" hole at each of the 4 previously marked locations.

WARNING! USE CARE NOT TO DRILL INTO OR DAMAGE ANY WIRE, AIR LINES OR OTHER COMPONENTS LOCATED BEHIND THE FRAME RAIL.



Figure 10

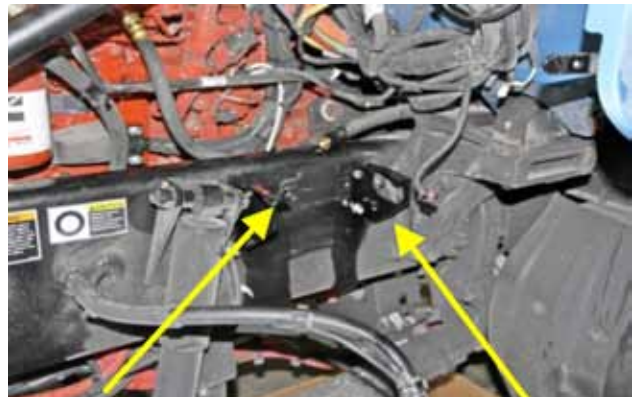

Figure 11

5A-6. Loosely assemble the mounting brackets and AirDog® to the frame. After mounting the AirDog® on the brackets, snug the fasteners to achieve a good relaxed fit, then finish tightening all of the fasteners.

OPTIONAL KIT AVAILABLE (PN: SBK-1000)

NO DRILL Universal Sandwich Mounting Bracket

Determine which holes in bracket 1 that you are going to need by holding it up to the frame of your vehicle.

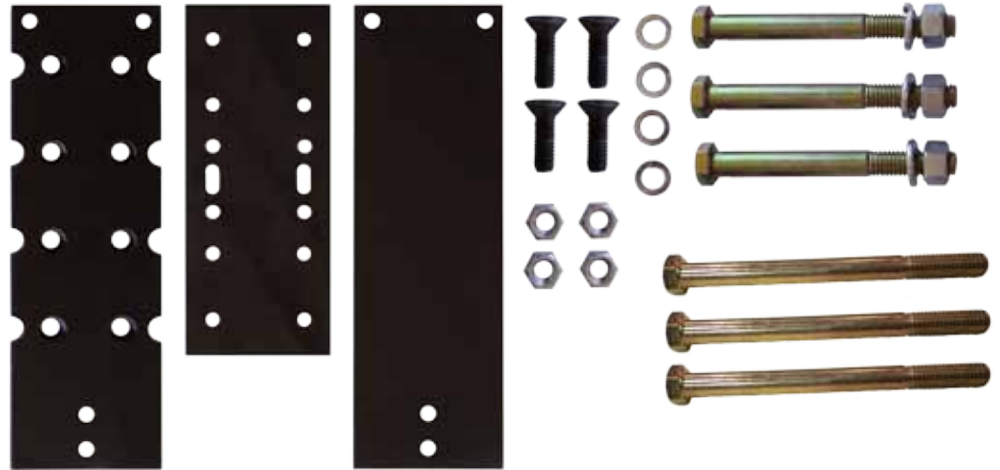

Use mounting hardware to mount bracket 1 to bracket 2. The position of bracket 2 can be adjusted vertically and horizontally to suit your particular needs.

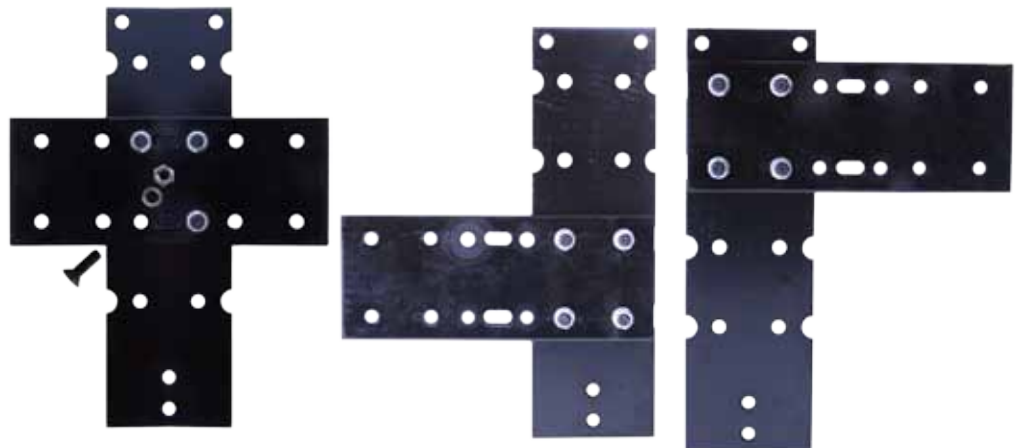

Using product mounting hardware, mount product to brackets.

Install 2 of the frame bracket bolts in top of bracket 1 & bracket 3. Slide over frame and install bottom bolt.

Note: 3.5" and 4.5" bolts are included. Use the length best suited to your vehicle's frame width.

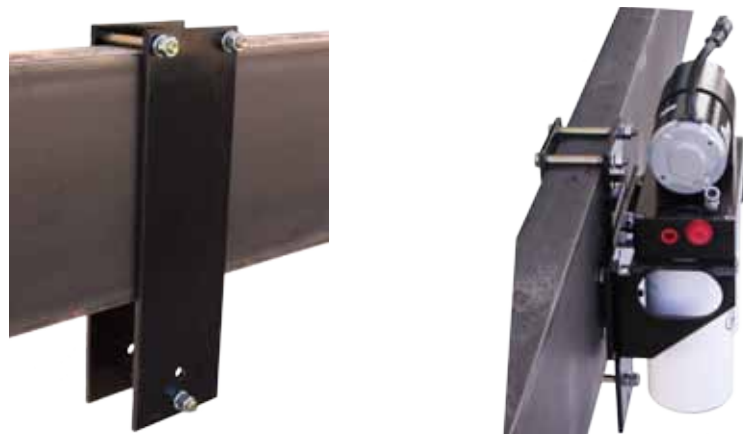

Tighten bolts as needed. Install filter or filter and water separator as applicable.

Mounting the AirDog® on the original filter bracket

5B-1. Remove the original fuel filter from the mounting bracket (Figure 13).



Figure 12



Figure 13

5B-2. Attach the AirDog® mounting brackets to the original filter plate. If the original bracket is not wide enough to fit the AirDog® brackets, bolt a plate to the bracket.

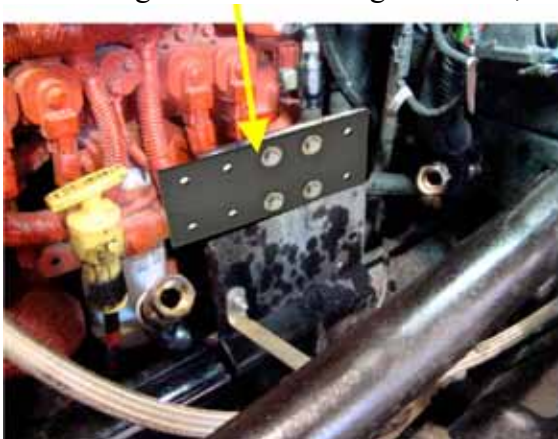

Figure 14

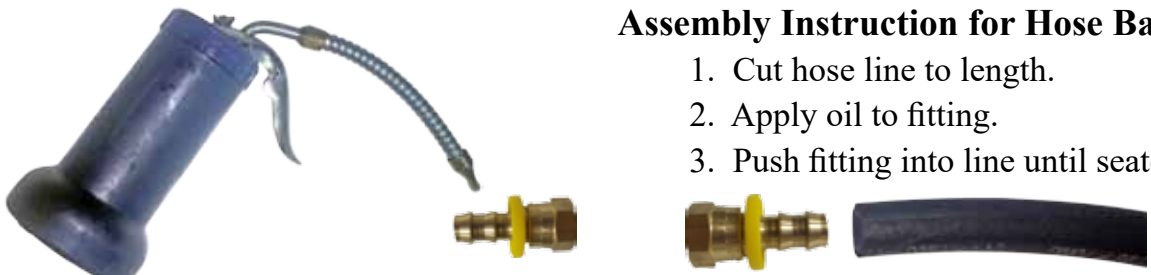

Figure 15

5B-3. Loosely assemble the brackets to the plate and the AirDog® to the brackets.

5B-4. After mounting the AirDog® on the brackets, snug the fasteners to achieve a good relaxed fit, finish tightening all of the fasteners.

NOTE: These steps are necessary to prevent stress cracks from forming in the mounting brackets due to vibration.



Assembly Instruction for Hose Barb

1. Cut hose line to length.
2. Apply oil to fitting.
3. Push fitting into line until seated.

FUEL LINE OVERVIEW

The AirDog® has been engineered to eliminate fuel related problems. It is important that the fuel lines are assembled and installed properly so as not to cause fuel flow restriction.

When possible, use the fuel lines that are on the vehicle. This will reduce your installation costs and make the installation go much more quickly.

NOTE: On various class 8 trucks, the manufacturer may use other than traditional steel braid fuel lines. These lines require special fittings. The fittings used with the original primary fuel filter are specific to the fuel lines used on the truck. When necessary and /or possible, utilize the OE fittings from the original fuel filter head. Always inspect the original fuel lines for size, length, and condition. If the fuel lines are in good condition and the correct size and length to adequately reach the AirDog®, you may want to go ahead and use them. If any of the fuel lines need to be replaced, it is recommended that the fuel lines selected meet or exceed DOT requirements.

Fuel Supply Line: The fuel supply lines from the tank to the AirDog® and to the engine should be size 10 or, at the absolute minimum, size 8 (1/2" ID).

Air/Vapor Return Line: The AirDog® Air/Vapor return line can be connected to the engine's return line. A size 6 is adequate for the Air/Vapor return line.

Primary Fuel Filters: It is most important that there are no fuel filters between the fuel tank and the AirDog® or between the AirDog® and the engine's transfer pump to plug and cause restriction. These filters should be removed from the system as part of the AirDog® installation.

Secondary Fuel Filters: DO NOT REMOVE SECONDARY FUEL FILTERS. This is the filter between the transfer pump and the engine.

Section 6A: Installing the Fuel Fittings and Low Fuel Pressure Sensor

FOR TRUCKS WITH JIC FUEL LINE CONNECTOR FITTINGS

NOTE: Figures 16 & 17 illustrate the installation of straight fittings. In some instances, 90° fittings may be required to connect the fuel lines to the AirDog®. Therefore, for your convenience two extra 90° fittings have been included in the kit for use as needed.

6A-1. Install the straight #10 JIC x 1/2" NPT fuel fitting in the AirDog® fuel port marked "ENGINE". Use the 90° swivel fittings as needed when connecting the lines.

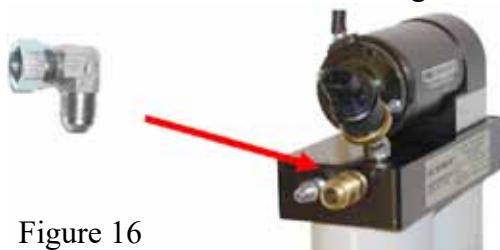

Figure 16



Figure 17

6A-2. Install a straight #10 JIC x 1/2" NPT fuel fitting into the fuel inlet port next to the regulator marked "FUEL IN". Use the 90° swivel fittings as needed.

PROCEED TO 6A-17.

**FOR TRUCKS WITH DAVCO FILTER HOUSING WITH
PLASTIC QUICK CONNECT FUEL LINES**

6A-3. Drain the fuel into a suitable container, from drain valve on bottom of filter housing.



6A-4. Disconnect the fuel line from the fittings in the filter housing.

6A-5. Remove the original primary filter assembly from the frame.

6A-6. Install a 1/2 Quick Connect X 1/2 NPT Adapter (PN 001-4A-1-0050) in the AirDog® fuel port marked “ENGINE”.



6A-7. Install a 1/2 Quick Connect X 1/2 NPT Adapter (PN 001-4A-1-0050) in the AirDog® fuel port marked “FUEL IN”.

6A-8. Connect the factory fuel line to the engine to the AirDog® out to “ENGINE” port.

6A-9. Connect the factory fuel supply line to the AirDog® “FUEL IN” port.

PROCEED TO 6A-17.

**FOR TRUCKS WITH PACCAR FILTER HOUSING WITH
QUICK CONNECT FUEL LINES**

6A-10. Drain the fuel into a suitable container, from drain valve on bottom of filter housing.

6A-11. Disconnect the fuel line from the fittings in the filter housing.

6A-12. Remove the original primary filter assembly from the frame.

6A-13. Install a Quick Connect 1/2 Return Adapter (PN 001-4A-1-0052) in the AirDog® fuel port marked “ENGINE”.

6A-14. Install a Quick Connect 1/2 Return Adapter (PN 001-4A-1-0052) in the AirDog® fuel port marked “FUEL IN”.

6A-15. Connect the factory fuel line to the engine to the AirDog® out to “ENGINE” port.

6A-16. Connect the factory fuel supply line to the AirDog® “FUEL IN” port.

PROCEED TO 6A-17.



LOW FUEL PRESSURE SENSOR

6A-17. Install the ¼” NPT x #6 JIC Male Air/Vapor return fitting into the Air/Vapor return port marked “TANK”.



6A-18. Remove the 1/8” NPT plug from the end of the pre-installed 45° fitting in the AirDog® base. Install the fuel pressure sensor into the 45° elbow.

SECTION 6B: Installing the AirDog® Return Line

VERY IMPORTANT: The AirDog® Air/Vapor return line is connected directly to the engine fuel return line.

You will use one of these options based on your engine setup:

- The Quick Connect Return Adapter Sub-Assy (PN 908-VM-QCRA) accomodates the AirDog® air/vapor return line on trucks **equipped with plastic fuel lines.**



- The #8M JIC x #8F JICX x 1/4 NPTF Port GagePort (PN 4A-1-11-08-08-4P) and the #6M JIC x 1/4 M NPTF Straight Connector (PN 4A-1-01-A-C-SZ) accomodate the AirDog® air/vapor return line on trucks **equipped with steel braided reinforced fuel lines.**



- The 1/2 F NPT Tee (PN 4A-4-03-08-08-08-S), the 1/2 Quick Connect x 1/2 NPT Adapters (PN 001-4A-1-0050) and the #8M JIC x 1/2M NPT Straight Connector (PN 4A-1-01-08-08-S) accomodate the AirDog® air/vapor return line on trucks **equipped with a Pacaar fuel filter housing.**



VERY IMPORTANT: When the ignition is activated, the primer/Lift Pump will start to pump. The AirDog® will also start to pump. the two together can produce pressures of up to 45 PSI. This will immediately trigger a high pressure fault code. **Therefore, the primer / lift pump must be deactivated by unplugging the power lead.**

AirDog® Return Line Trucks Equipped with Quick Connect Plastic Fuel Lines

6B-1A. Remove the factory quick connect fuel line, and install the provided quick connect return adapter (PN 908-VM-QCRA) into the factory fitting. **Be sure to lubricate the o-ring on the adapter and ensure the fitting is fully seated.** Then secure the fitting with the provided retainer clip.



6B-1B. Install factory fuel return line into the female side of quick connect return fitting. Once line is fully seated, secure with factory retainer clip.

PROCEED TO 6B-4A.

Trucks Equipped with Steel Braided Reinforced Lines

6B-2A. Disconnect the engine fuel return line from the #8 JIC flare fitting located on the side of the engine and remove the original fuel return fitting.



6B-2B. Install #6M JIC x 1/4 M NPTF Straight Connector (PN 4A-1-01-A-C-SZ) into #8M JIC x #8F JICX x 1/4 NPTF Port GagePort (PN 4A-1-11-08-08-4P). Then install this Gageport Fitting Assembly onto the engine fuel return fitting.



6B-2C. Connect the factory fuel return line onto the GagePort Assembly.

PROCEED TO 6B-4A.

Trucks Equipped with Paccar Fuel Filter Housing

6B-3A. Disconnect the two return lines located on top of the Paccar fuel filter housing.

6B-3B. Install two 1/2 Quick Connect x 1/2 NPT Adapters (PN 001-4A-1-0050) into side ports of the 1/2 F NPT Tee (PN 4A-4-03-08-08-08-S).

6B-3C. Install #8M JIC x 1/2 M NPT Straight Connector (PN 4A-1-01-08-08-S) into the top port of the 1/2 NPT Tee.



6B-3D. Connect factory fuel return line into Quick Connect fittings in side ports of tee.

PROCEED TO 6B-4A.

AirDog® Return Line

6B-4A. Measure and cut a length of fuel line necessary to reach from the AirDog® Air/Vapor return fitting to the air/vapor return fitting in the fuel return tee.

6B-4B. Assemble the fuel line with the proper end fittings for the connections.

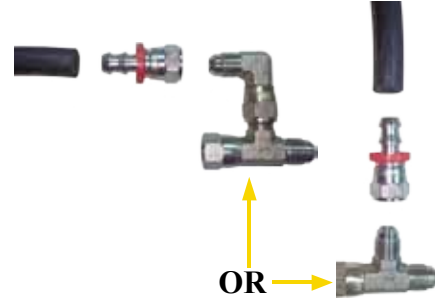

NOTE: This assembled fuel line is for illustration only. Use the proper end fittings that apply to your application!

6B-4C. Route and connect the Air/Vapor return line to the proper fittings on the AirDog® and the return tee (Refer to section 6B on Page 14). Properly tighten the fittings. Secure the fuel line with zip ties as necessary to prevent abrasion and chafing.



* Use #8 JICX x 3/8 Push-Lock Hose Barb (PN 4A-1-09-08-06-B) to connect AirDog® return line to the top port of this tee.

SECTION 6C: Connecting the AirDog® to the Engine & Tank

6C-1. Connect the fuel line from the tank to the fitting in the AirDog® “FUEL IN” port.

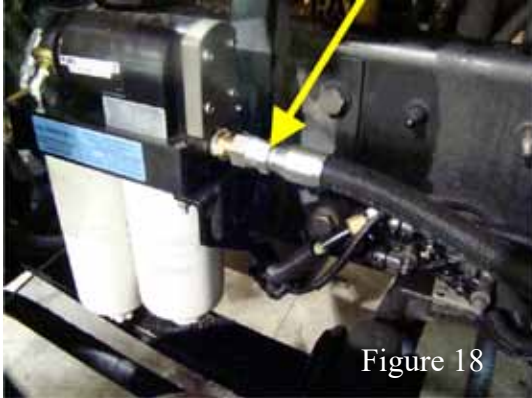

Figure 18

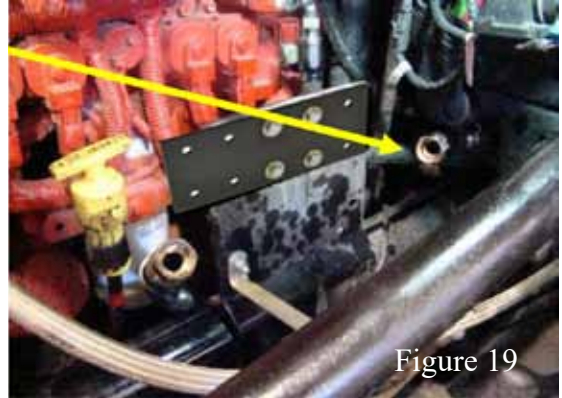

Figure 19

Connecting the AirDog® to the Engine and Tank on vehicles with plastic fuel lines

6C-2. Remove the fittings for the plastic lines from the original filter assemblies and install them in their respective inlet and outlet ports in the AirDog®.

6C-3. Connect the fuel line to the engine to the AirDog® fuel outlet fitting.



Figure 20

FUEL LINE from AirDog® TO ENGINE

6C-4. Connect the fuel line from the tank to the AirDog® fuel inlet fitting.



Figure 21

FUEL LINE from TANK to AirDog®

WIRE HARNESS

***VERY IMPORTANT: The AirDog® wire harness requires a 15 amp fuse.**

The AirDog® wire harness has a low pressure sensor and an amber LED indicator light as standard equipment. The indicator light will illuminate at start-up, remain on for a few seconds, then go off and should remain off unless pressure flow to the engine drops below minimum requirements.

THE AIRDOG® WIRE HARNESS

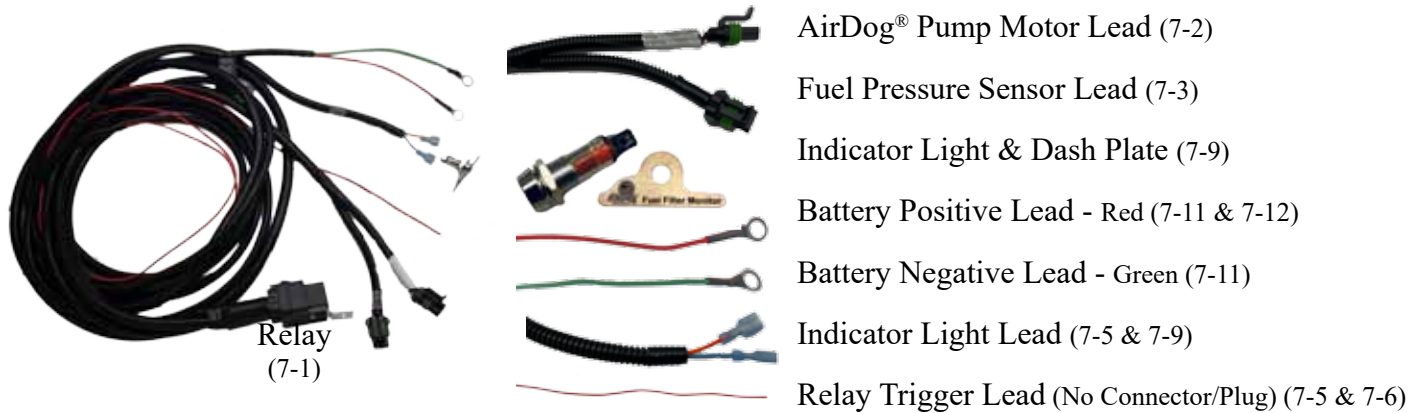

Securing the AirDog® Wire Harness Relay to the Vehicle

7-1. Secure the AirDog® wire harness relay to the vehicle. This picture shows the relay mounted on the firewall.



7-2. Route the AirDog® wire harness pump motor lead and the fuel pressure sensor lead to the AirDog® unit. Connect the wire harness pump motor lead (labeled “Attach to Motor”) to the AirDog® unit pump motor lead.



7-3. Connect the AirDog® wire harness fuel pressure sensor lead to the AirDog® unit fuel pressure sensor.

Relay Trigger Lead and Indicator Light Lead

The AirDog® Wire Harness Indicator Light lead must be routed through the firewall and to the dash board. The Relay Trigger Lead must be connected to a contact point that is electrically “HOT” when the key is in the “RUN” position. This could be either in a spare fuse holder in the fuse panel or on the ignition switch itself.

Note: DO NOT connect the AirDog® wire harness relay trigger lead to a point that is “HOT” when the key is in the ACCESSORY position.

Routing the Indicator Light and Relay Trigger Lead through the firewall:

7-4. Most Peterbilts and Kenworths have access holes located below the steering column. Remove the plug and route the leads through the hole. For other make trucks, drill a 5/8” hole in firewall to allow entry of the indicator light lead into the cab. Use the grommet to seal around the loom cover.



7-5. Route the AirDog® wire harness trigger lead (red wire with no connector/plug) and indicator light lead through the firewall.

By the Steering Column

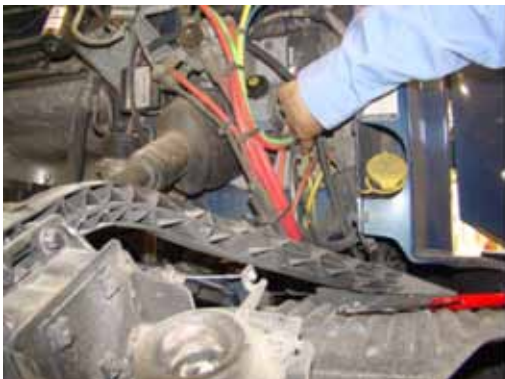

Under the Dash

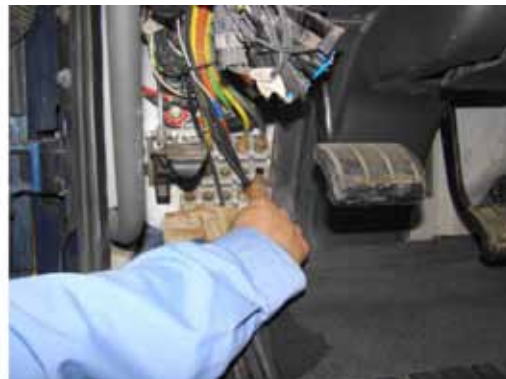

NOTE: Be sure to seal the opening or install a grommet around the wire loom to prevent water leakage and protection from chafing.

Relay Trigger Lead and Indicator Light Lead, cont'd

7-6. Connect the red relay trigger lead to a terminal on the ignition switch that is “HOT” when the ignition key is in the “RUN” position **OR** connect the red relay trigger lead to a fuse holder in the fuse panel that is “HOT” when the ignition key is in the “RUN” position.

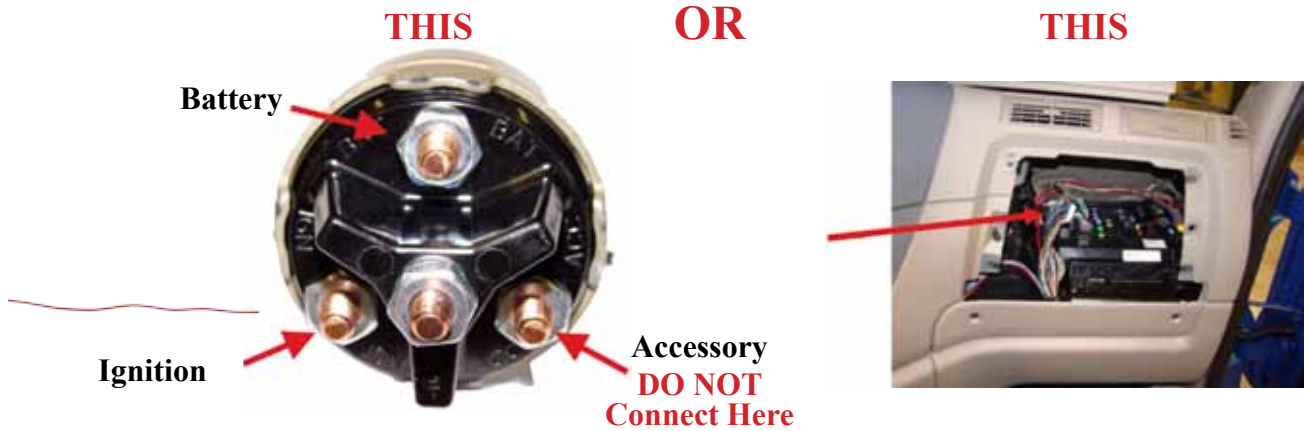

INSTALLING THE AIRDOG® WIRE HARNESS INDICATOR LIGHT

Amber LED Indicator Light

7-7. Select a location on the dash that is easily visible to the driver. Remove the dash components as necessary to access the area behind the selected location.



Installing the Indicator Light, Cont'd

7-8. Drill a 7/16" hole in the dash at the selected location. Be very careful when drilling. Do not damage components located behind the dash. Remove the nut from the indicator light.



7-9. Install the dash plate and indicator light in the dash. *Note-to adhere plate to dash, you may peel off the paper backing from the backside of the plate to expose adhesive. Reinstall nut and tighten until snug. Connect the positive (orange wire) lead on the wire harness to the positive (marked orange) quick connect terminal on the indicator light (see image above). Then connect the negative (blue wire) lead on the wire harness to the negative (unmarked) quick connect terminal on the indicator light.

7-10. Re-assemble the dash components back to their original position.

CONNECTING THE POWER SUPPLY LEADS

The power supply leads can be easily connected to the appropriate contacts on the alternator. Any high amperage terminal that is always "HOT" is OK for the Positive + (RED) lead. Be sure the NEGATIVE - (GREEN) lead is connected to a reliable chassis ground.

7-11. Route the red & green power leads to the alternator. Connect the green (-) ground lead to the alternator **Ground** connection.



7-12. Connect the red (+) positive lead to the alternator **Hot Lead** going to the battery.

NOTE: Secure wire harness with zip ties included in installation kit.

SECTION 8: INITIAL START UP PROCEDURE

The AirDog® is a self priming system. However, to prevent damage to a dry seal and reduce the life expectancy of the system, it is suggested to pre-fill the water separator/pre-filter with diesel fuel to the bottom of the “NUT PLATE”.

- 8-1. Rub CLEAN diesel fuel or oil on filter seals before installing to ensure a proper seal.
- 8-2. Pre-fill the water separator/pre-filter with diesel fuel up to the bottom of the nut plate.
- 8-3. Turn the starter key to the on/run position.
- 8-4. The AirDog® should now be running and pumping fuel, bleed the fuel line to the engine by loosening the fuel line connection at the engine fitting. As soon as the line is purged of air and pure fuel is observed, properly tighten the fuel fitting.

NOTE: Put a rag or shop towel over and around the fitting to prevent fuel splatter or spray. Catch all spilled fuel and dispose of properly. Wear safety glasses.

- 8-5. Start the engine.

RECHECK ALL FUEL FITTINGS FOR LEAKAGE AND PROPER TORQUE. BE SURE ALL FUEL LINES ARE PROPERLY ROUTED TO PROTECT FROM EXCESSIVE HEAT AND SECURED TO PROTECT FROM CHAFING AND ABRASION. RECHECK ALL ELECTRICAL LINES, SECURE AS NECESSARY.

Servicing the AirDog® Fuel Filter and Water Separator/Pre-Filter

It is highly recommended that you keep a replacement AirDog® fuel filter and water separator on-hand, ready for replacement when the AirDog® Indicator Light illuminates.

When the particulate fuel filter, water separator, mesh screen in the water separator nipple, or a combination of these, become plugged, the restriction will cause a loss in pressure and flow through the AirDog® system, which will cause the AirDog® Indicator Light to illuminate, and stay on. When the Indicator Light comes on, this indicates it is time for a filter change. It is strongly recommended that BOTH filters be changed at the same time. After changing filters, if the Indicator Light remains on, please check that the AirDog® fuel pump is running, with the key in the “RUN” position. If the pump is not running, check the fuse in the wire harness, located near the AirDog® wire harness terminals connected to the battery or alternator for power. It is possible for a restriction in flow to cause the pump to draw high amps for a short period of time, which could pop the 15A fuse in the harness. Replace the fuse, if blown. After replacing the fuse, if the Indicator Light remains on, please use the following procedure to check for debris in the water separator nipple:

- Remove the water separator from the AirDog® filter base.
- Using a 1-1/8” (29mm) deep-well socket, loosen and remove the threaded nipple that the water separator was installed on.
- Inspect the wire mesh screen inside the nipple, blow any debris out of the screen with compressed air.
- Reinstall the threaded nipple into the AirDog® filter base.
- Tighten the nipple securely with the socket and ratchet. Torque spec for the nipple installation is 35 FT-LBS.

FUEL FILTER: The AirDog® 6-micron fuel filters have a typical lifespan of 25,000+ miles, and up to 40,000 miles, as they are manufactured with a high-quality and high-capacity Micro-glass media, as opposed to a paper element. Fuel filter life is affected by many variables. In any case, we do not recommend exceeding 40,000 miles of service with a fuel filter.

When replacing the fuel filter, be sure to clean the underside of the AirDog® filter base. Rub clean diesel fuel or oil on filter seals before installing, to ensure a proper seal.

It is not necessary to pre-fill the fuel filter with fuel; the AirDog® integrated fuel pump will fill the filter and prime the system automatically. Follow the instructions on the filter for proper tightening procedures.



WATER SEPARATOR: The AirDog® water separator/pre-filters have a typical lifespan of up to 40,000 miles, as they are manufactured with a high-quality and high-absorbency Hydrosorb media. Replace the water separator when the AirDog® Indicator Light illuminates, if it becomes damaged or permanently plugged, and when changing the AirDog® fuel filter. Before installing a new water separator, be sure to clean the underside of the AirDog® filter base. Rub clean diesel fuel or oil on filter seals, to ensure a proper seal. It is suggested that you pre-fill the water separator (only) with clean diesel fuel when changing filters, to assist the system with priming. Follow the instructions printed on the water separator/pre-filter for proper tightening procedures.

When tightening filters with a filter wrench, DO NOT overtighten, as doing so may damage the filters.

Caution: Be careful to prevent any contaminants from entering the water separator when replacing. Although the water separator pre-filter has a protective wire screen, any debris passing through the system could cause the Gerotor fuel pump to lock up, which can cause the in-line fuse to blow. Such a pump lock-up is not covered under warranty.

DISPOSE OF WASTE FUEL AND USED FILTERS PROPERLY TO PROTECT OUR ENVIRONMENT!



www.airdogdiesel.com
1-877-463-4373 or
1-573-635-0555

Copyright© 2016
CD Patents, LLC

Bulletin No. 206-1-0453
Revised May 06,2024

All Rights Reserved